

LightBoard / Light Box

This product is a 0.31-inch thick acrylic sheet with LEDs on one or more edges. Light is distributed evenly throughout the panel by “V” cut grooves on one face of the acrylic.

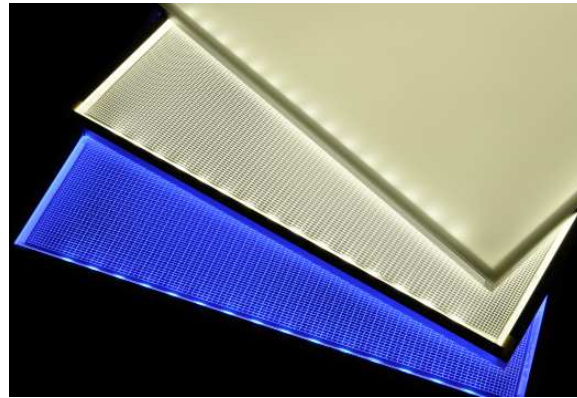

Uses

- Signs
- Architectural lighting
- Floors
- Lighted walls
- Furniture
- Retail displays
- Lighted shelves
- Back light stone
- Stained glass
- Faux window or skylight
- Under cabinet lighting
- Drawing table
- Photography/Videography

LightBoard / Light Box



(Top) Milky White Diffusion Sheet Optional

Description:	
Voltage	Either 12 or 24-vdc
Power	4.5-watts per linear foot of LED strip used to illuminate the panel
Weight	2-pounds per square foot
Size	4 x 4-inches to 48 x 96-inches
Color Temperature (K) \pm 200	3,200, 3,700, 4,200, 4,700, 5,300, 6,500, 7,500, Red, Green, Blue
Dimming	Yes, with pulse width dimmer
UL	Yes (Sign Accessory & Luminaire)
Operating Temperature	-4 ~ + 95°F
Life	>50,000-hours, 2 year guarantee
Brightness	4,000-49,000 lux (dependent on size and qty. of LEDs used)
Application	Dry location
Construction	Acrylic with aluminum edge (heat sink)

Examples of Panel Brightnes			
Size (inches)	Brightness (Lx)	Power	Lighted Edges
3.75 x 3.75	25,000	2.25	2
3.75 x 3.75	49,000	4.5	4
6 x 6	8,500	2	1
6 x 6	17,000	4	2
6 x 6	32,000	8	4
12 x 12	8,000	9	2
12 x 12	15,000	18	4
24 x 24	4,000	18	2
24 x 24	7,000	32	4

Typical Photometric Data 3,700K

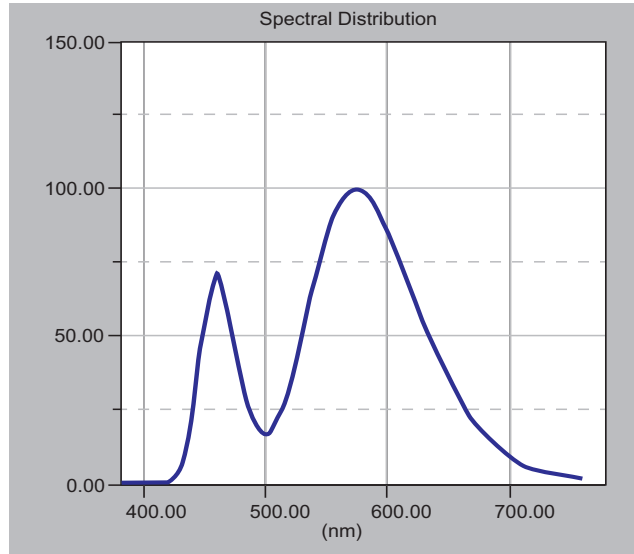

Measured Spectral Power Distribution

Wavelength (nm)	Normalized-100*	Wavelength (nm)	Normalized-100*
382.5	0.35	581.4	98.50
387.6	0.06	590.9	93.61
396.2	0.00	600.7	84.85
406.7	0.08	610.4	74.21
417.4	0.42	620.0	63.74
428.0	3.19	629.5	54.03
438.5	18.16	639.0	44.88
449.1	52.24	648.5	36.40
459.6	71.36	657.9	29.22
470.0	56.73	667.3	23.22
480.4	33.31	676.6	18.32
490.7	20.14	685.7	14.28
501.0	17.21	694.8	11.24
511.2	23.02	704.0	8.42
521.3	36.10	713.1	6.13
531.5	53.39	722.0	5.10
541.5	71.20	730.9	4.01
551.4	86.57	739.9	3.33
561.5	96.48	748.7	2.59
571.6	100.00	757.6	2.30

* Spectral data are displayed normalized to a maximum value of 100.00

Typical Photometric Data 5,300K

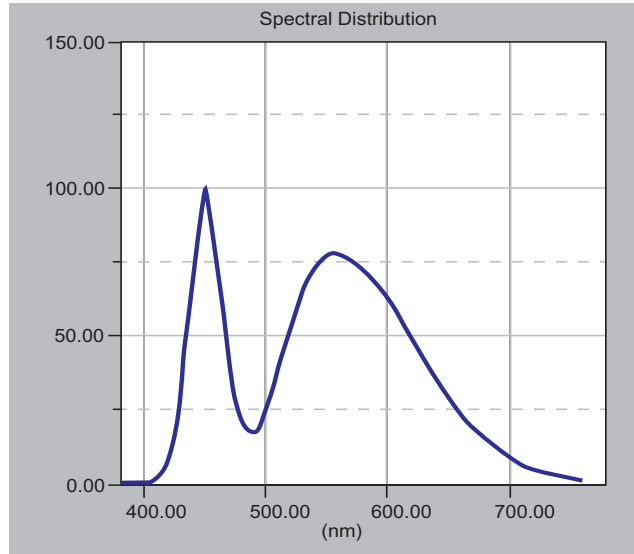

Measured Spectral Power Distribution

Wavelength (nm)	Normalized-100*	Wavelength (nm)	Normalized-100*
382.5	0.35	581.4	72.09
387.6	0.24	590.9	67.86
396.2	0.16	600.7	62.05
406.7	1.35	610.4	55.20
417.4	8.05	620.0	48.36
428.0	30.76	629.5	41.96
438.5	76.36	639.0	35.72
449.1	100.00	648.5	29.69
459.6	70.85	657.9	24.27
470.0	33.98	667.3	19.68
480.4	18.18	676.6	15.89
490.7	17.05	685.7	12.86
501.0	26.42	694.8	10.20
511.2	42.26	704.0	7.86
521.3	57.99	713.1	6.23
531.5	69.10	722.0	4.26
541.5	75.10	730.9	3.22
551.4	77.79	739.9	2.45
561.5	77.60	748.7	2.64
571.6	75.33	757.6	2.21

* Spectral data are displayed normalized to a maximum value of 100.00

LightBoard RGB (Red, Green, Blue)

Red, Green and Blue panels are available with or without controllers. By mixing these 3 primary colors, it is possible to create 16-million colors. Custom fabrication available.

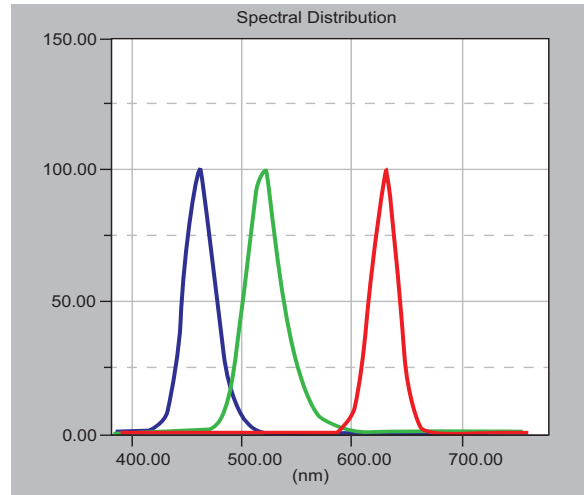
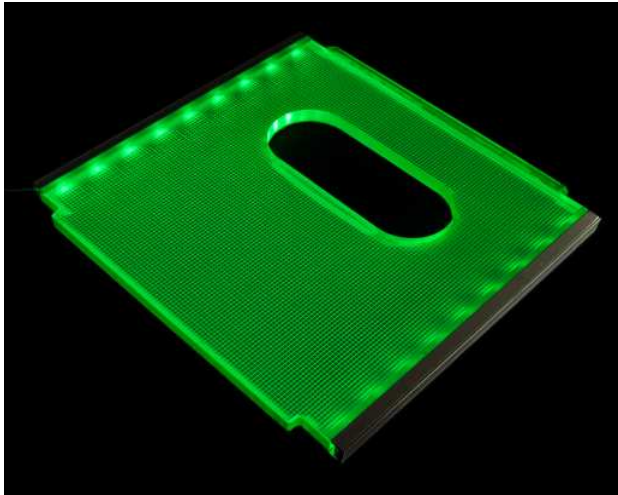

Description:	
Voltage	12-vdc
Power	1.5-watts per color, per linear foot of LED strip used to illuminate the panel
Weight	2-pounds per square foot
Size	4 x 4 to 48 x 96-inches
Color	Red, Green, Blue
UL	Yes (Sign Accessory & Luminaire)
Operating Temperature	-4 ~ + 95°F
Life	>50,000-hours, 2 year guarantee
Application	Dry location
Construction	Acrylic with aluminum edge (heat sink)

LED Light Box

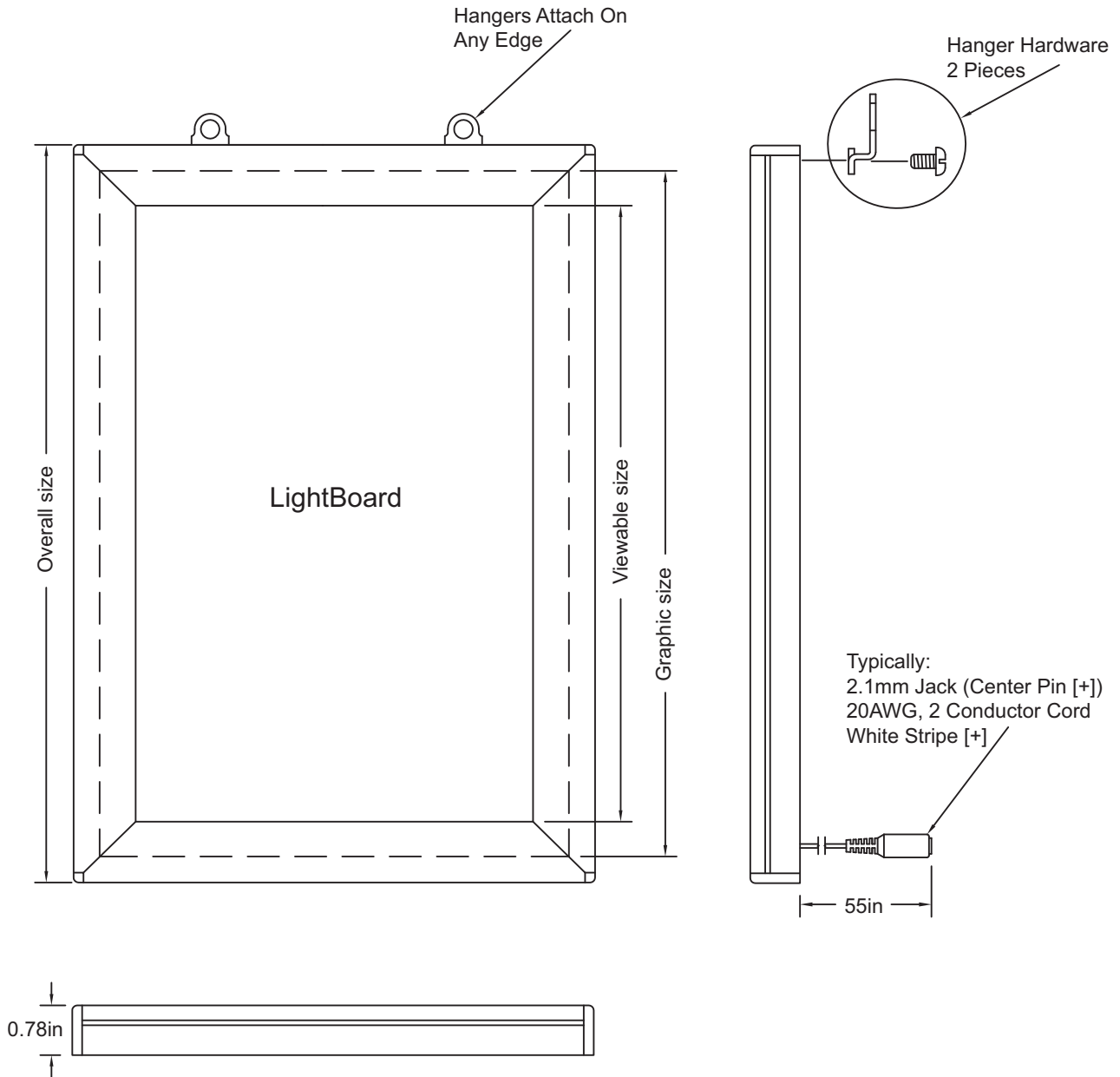

LightBoard Panel Design

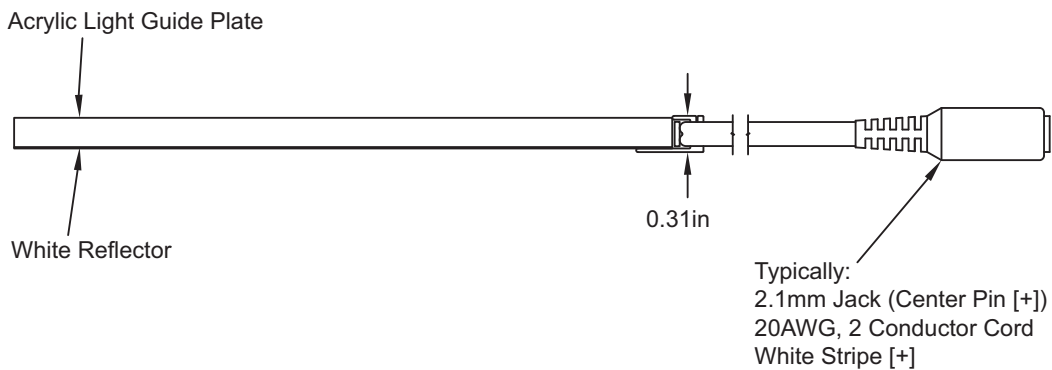
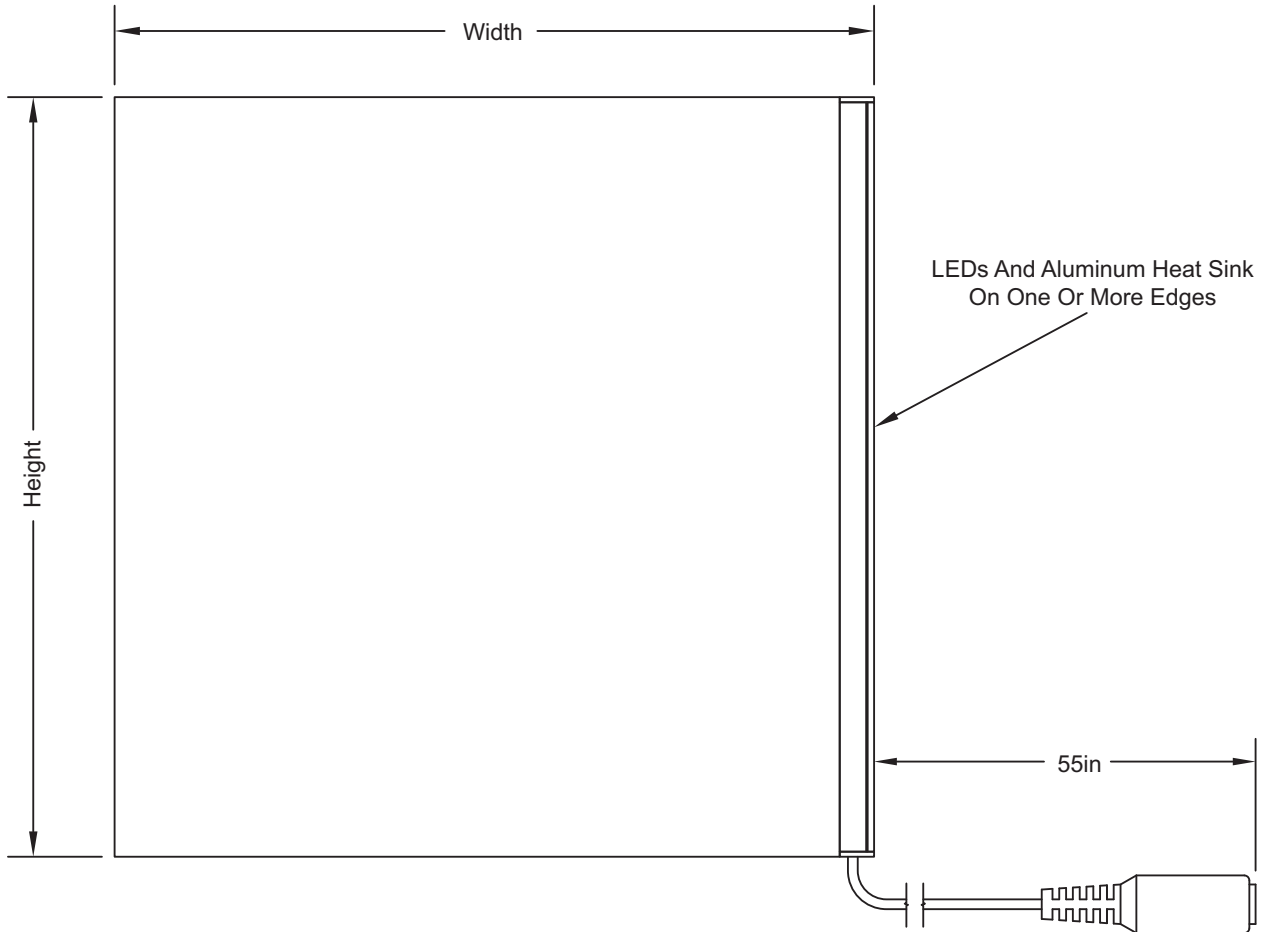

Illumice

An edge-lit light panel is known by several names; light board, light pad and light sheet. This product is a 0.31-inch thick acrylic sheet with LEDs on one or more edges. Light is distributed evenly throughout the panel by “V” cut grooves on one face of the acrylic.



Description:	
Voltage	12-vdc
Power	4.5-watts per linear foot of LED strip used to illuminate the panel
Weight	2-pounds per square foot
Size	4 x 4-inches to 48 x 96-inches
Color Temperature (K) ± 200	3,700, 5,300
Dimming	Yes, with pulse width dimmer
UL	Signs UL48
Operating Temperature	-4 ~ + 95°F
Life	70,000-hours, 3 year guarantee
Brightness	2,000-31,700 lux (dependent on size and quantity of LEDs used)
Application	Indoor
Construction	Acrylic

Illumice

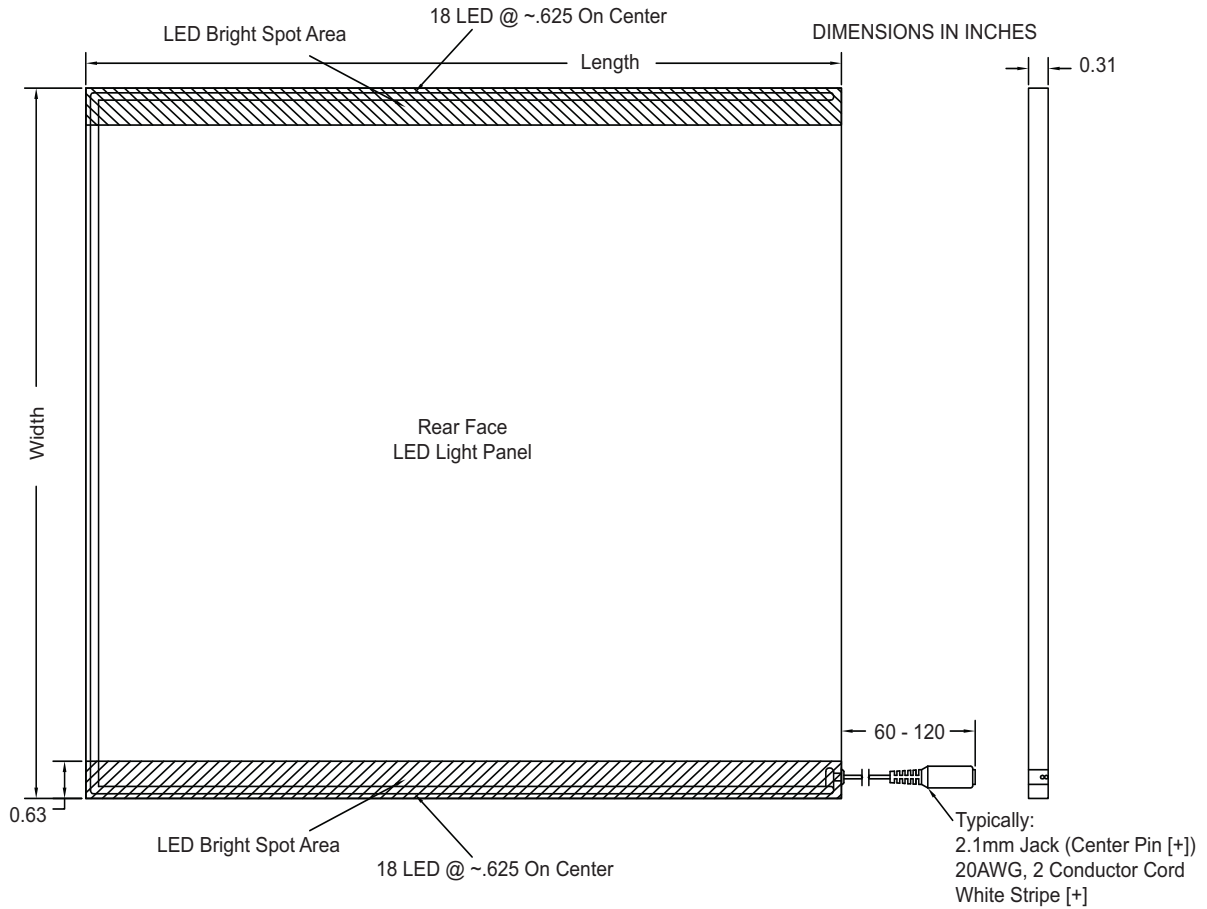

Examples of Panel Brightness			
Size (inches)	Brightness (Lx)	Power	Lighted Edges
3.75 x 3.75	5,200	2.25	2
3.75 x 3.75	31,700	4.5	4
6 x 6	6,043	2	1
6 x 6	6,817	4	2
6 x 6	23,701	8	4
12 x 12	5,048	9	2
12 x 12	11,310	18	4
24 x 24	2,724	18	2
24 x 24	5,883	32	4

Instructions for Handling & Installation

Please read all directions before carrying and installing LED edge-lit panels with or without flip-open frame (using mounting clips).

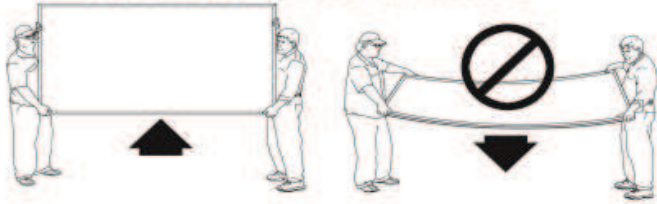

Step 1. Proper Handling of LED Edge-lit Panels & Light Boxes- Care should be taken to prevent breaking the acrylic light guide plate (LGP). While resting on a flat surface, raise one edge of the panel to a vertical position, lift and carry the panel in this position. Be careful to not pull on the power lead extending from the panel. Do not rest the panel on the power lead, damage to the wire's insulation may result.

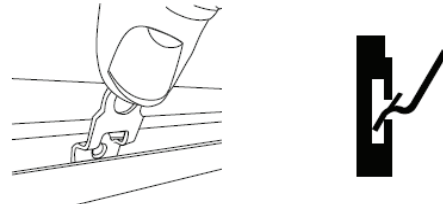

Step 2. Wall Mounting a Light Box- Insert the hanging clip into the channel on the top rear of the frame at approximately 45 degree angle.

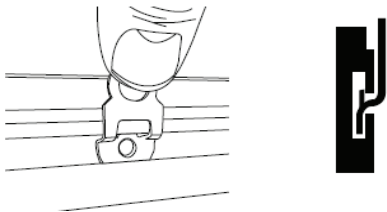

Step 3. Wall Mounting a Light Box Cont.- Using your thumb apply pressure to the upper portion of the clip, snapping it into the channel.

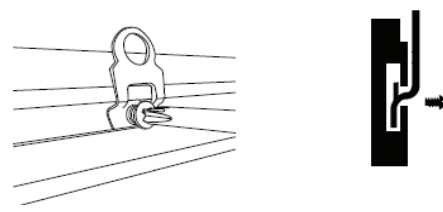

Step 4. Positioning Hanging Clip- Slide hanging clip to the desired location then insert and tighten locking screw using phillips screw driver. Repeat step 2 through 4 for second clip.

Limited Warranty

Knema, LLC., dba LuminousFilm (hereinafter 'Company'), provides the following limited warranty for LED lighting, Electroluminescent (EL) products and accessories purchased from Company by any Individual, Distributor, or OEM (hereinafter 'Purchaser'). This limited warranty applies as follows to new LED and EL Products purchased by Purchasers in the United States or Canada, which are accompanied by this written warranty.

Subject to the exclusions contained below, Company warrants its lighting products and accessories ("Products"), which are sold to Purchaser for the purpose of commercial and/or residential lighting uses, to be free from defects in materials and workmanship under normal usage for the period(s) stated below unless otherwise stated in product-specific documentation as longer or shorter term.

Electroluminescent Panels, 120-days

Flexible LED Strips, 1-year

Electroluminescent Inverters, 1-year

LED Edge-lit panels [with or without flip-open frame], 3-years

LED Modules Premium [Cree LEDs] manufactured by US Solid State, LLC., 7-years

LED Modules Economy [non Cree LEDs] manufactured by US Solid State, LLC., 3-years

Power Supplies, manufacturers warranty

Accessories, 90-days

EXCLUSIONS

Normal Wear, Periodic Maintenance:

Repair and replacement of parts due to normal wear and tear are excluded from coverage.

Abuse & Misuse:

Defects or damage that result from: (a) improper operation, improper installation, storage, misuse or abuse, accident or neglect, to the product resulting from misuse; (b) contact with liquid, water, rain, extreme humidity, or dirt or the like, or extreme heat, or other extreme environmental conditions.

There is no warranty, expressed or implied, as to fitness of any product for a particular purpose, nor for any certain level or type of performance in any particular environment or application. Warranty coverage is limited to the sale price of the product, regardless of consequential or inconsequential damages that may be incurred.

GENERAL TERMS

Replacement Policy for Defective Products:

The Company will replace (either brand new or factory reconditioned) or repair defective products, upon our approved inspection of the defective product [in the case of LED lighting products: 10% defective LEDs in the unit]. Knema, LLC., reserves the right to deliver a similar (equivalent) type of product, if the type of the original product is no longer available at the time of complaint. The repair, replacement, or additional delivery of the product neither renews nor extends the period of the Limited Warranty. The replaced product will become the property of the Company.

Limited Warranty Claim:

The Company will repair or replace the defective product at the Company's discretion. Company reserves the right to examine any products and/or accessories to determine the cause of failure and patterns of usage. The date of the purchase and installation must be verified to validate the elapsed operating hours if a warranty claim is made. If product life is not validated, the product date code will be used to establish elapsed time based on Company's estimate of usage. Some states do not allow the exclusion or limitation of incidental or consequential damages, so the above limitation or exclusion may not apply to you. This warranty gives you specific legal rights and you may also have other rights which vary from state to state. Warranty coverage does not include original or return freight costs. If warranty service is needed, contact Knema, LLC., 7288 Greenwood Road, Shreveport, Louisiana 71119 USA. You will receive instructions on how to ship the Product(s), at your expense, to the Company. To obtain the benefits of this warranty service, you must include a copy of your receipt, bill of sale or other comparable proof of purchase.