

LED Backlighting For Everything

This product is a 0.28-0.31-inch thick acrylic sheet with LEDs on one or more edges. Light is distributed evenly throughout the panel by "V" cut grooves on one face of the acrylic. Manufactured in South Korea.

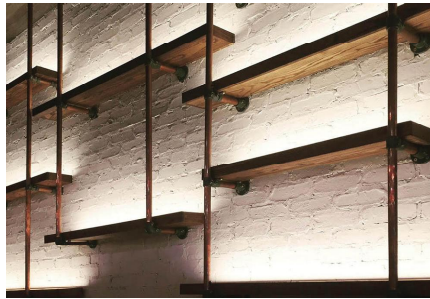

LightBoard

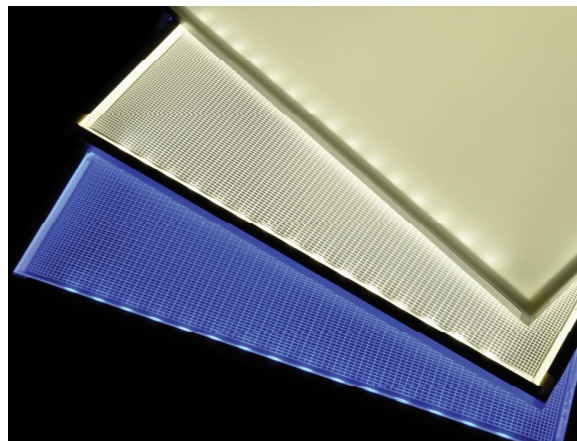
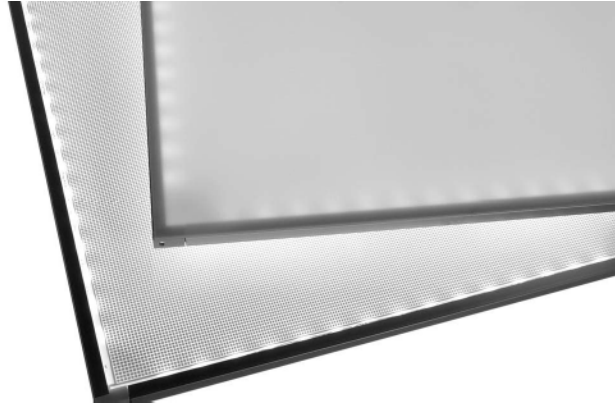

Description:	
Voltage	Either 12 or 24-vdc
Power	4.5-watts per linear foot of LED strip used to illuminate the panel
Weight	2-pounds per square foot
Size	4 x 4-inches to 48 x 96-inches
Color Temperature (K) ± 200	3,200, 3,700, 4,200, 4,700, 5,300, 6,500, 7,500, Red, Green, Blue
Dimming	Yes, with pulse width dimmer
UL	Yes (Sign Accessory & Luminaire)
Operating Temperature	-4 ~ + 95°F
Life	>50,000-hours, 2 year guarantee
Brightness	4,000-49,000 lux (dependent on size and qty. of LEDs used)
Application	Dry / Damp location
Construction	Acrylic with aluminum edge (heat sink)

LightBoard RGB (Red, Green, Blue)

Red, Green and Blue panels are available with or without controllers. By mixing these 3 primary colors, it is possible to create 16-million colors. Custom fabrication available.

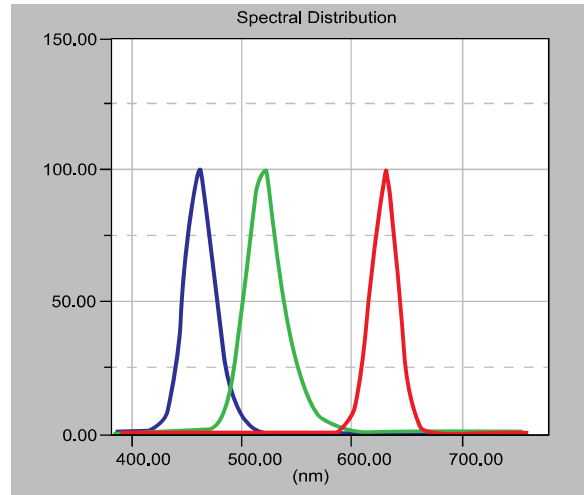
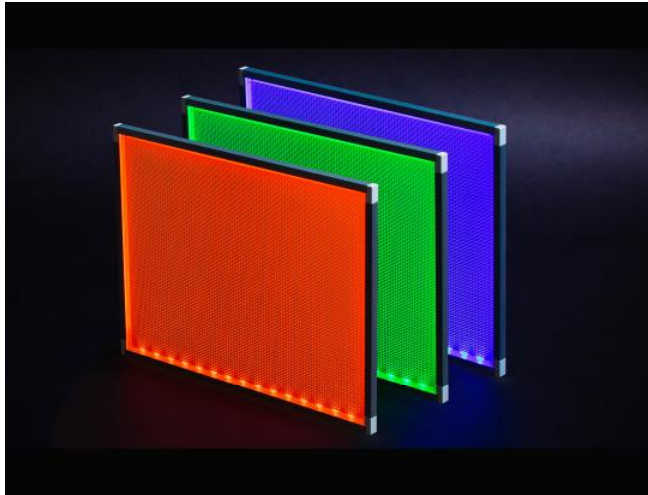

Description:	
Voltage	12-vdc / 24-vdc
Power	1.5-watts per color, per linear foot of LED strip used to illuminate the panel
Weight	2-pounds per square foot
Size	4 x 4 to 48 x 96-inches
Color	Red, Green, Blue
UL	Yes (Sign Accessory & Luminaire)
Operating Temperature	-4 ~ + 95°F
Life	>50,000-hours, 2 year guarantee
Application	Dry location
Construction	Acrylic with aluminum edge (heat sink)

LED Light Box

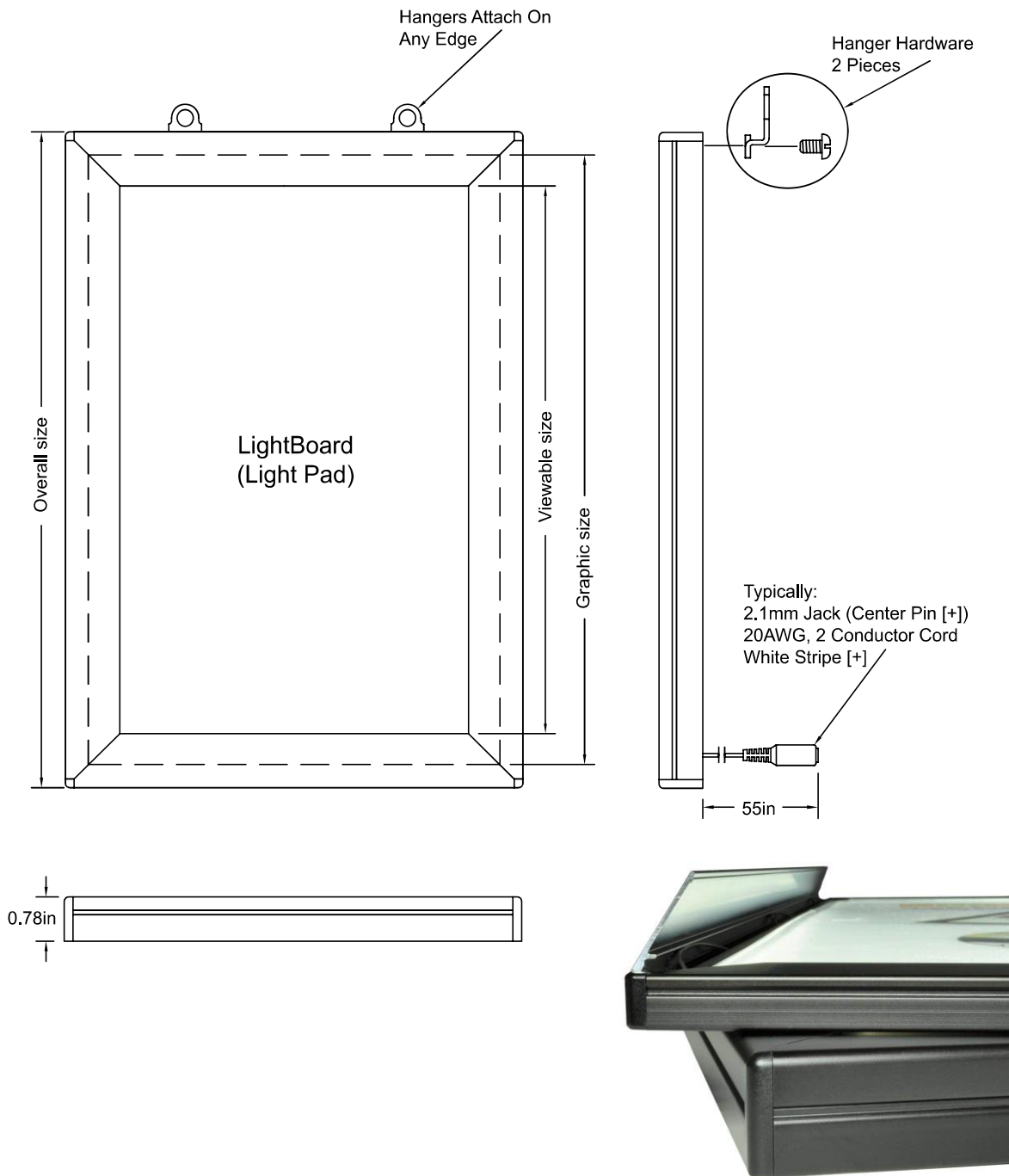

LightBoard Panel Design

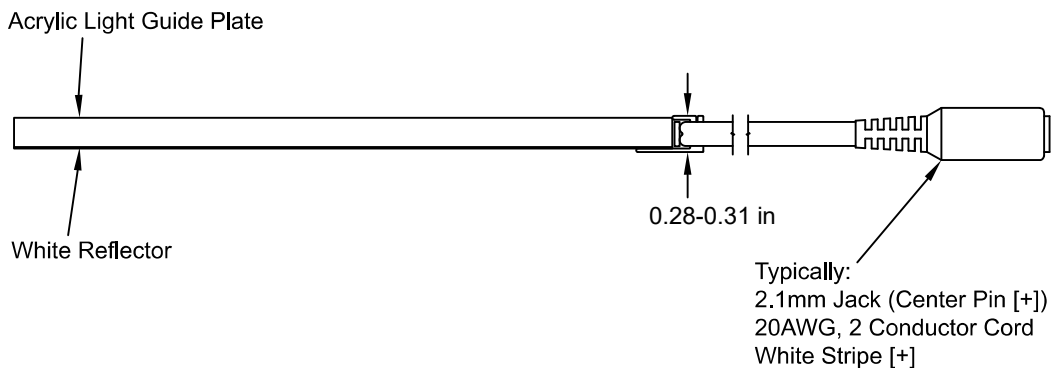
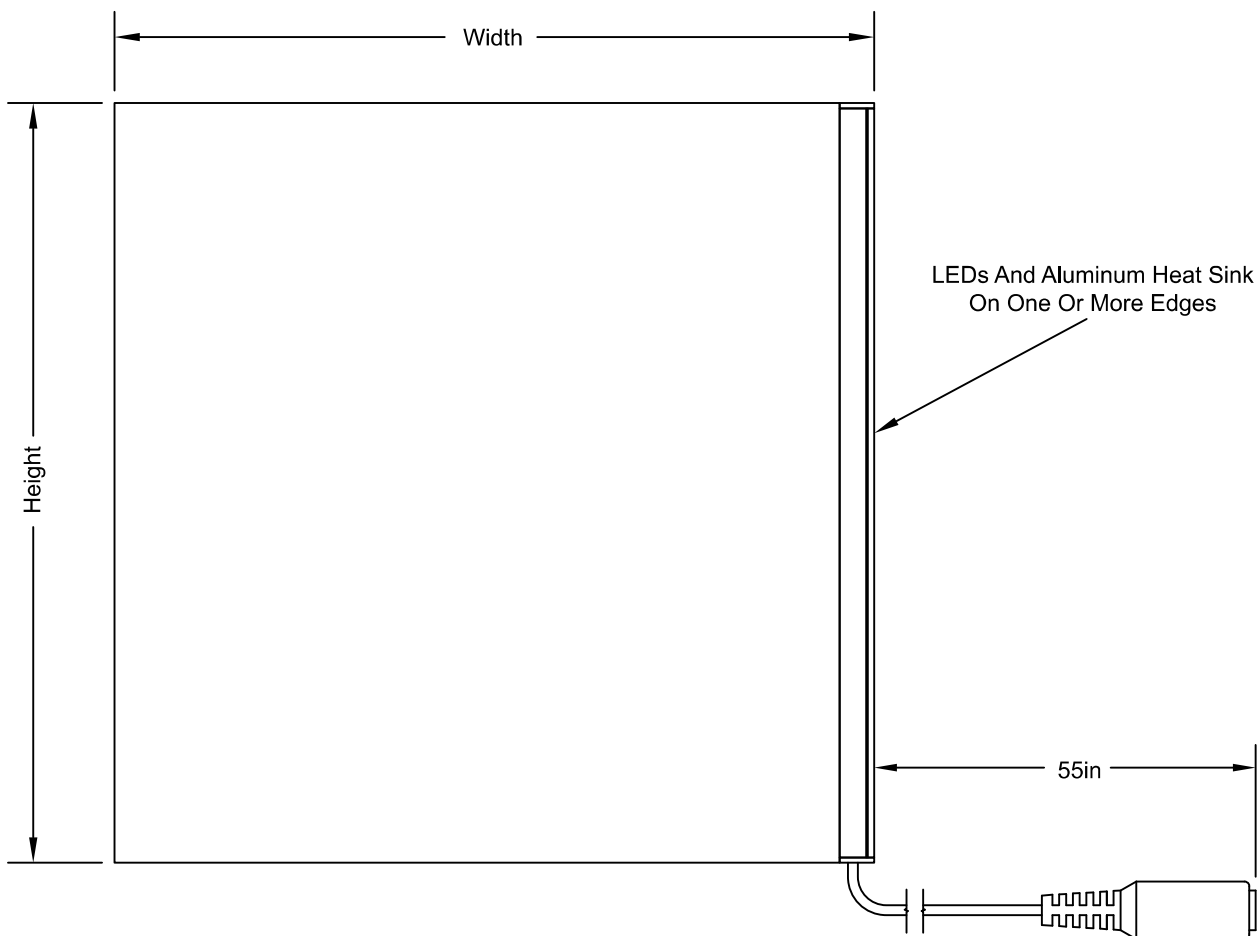

Illumice

An edge-lit light panel is known by several names; light board, light pad and light sheet. This product is a 0.28-0.31-inch thick acrylic sheet with LEDs on one or more edges. Light is distributed evenly throughout the panel by “V” cut grooves on one face of the acrylic.

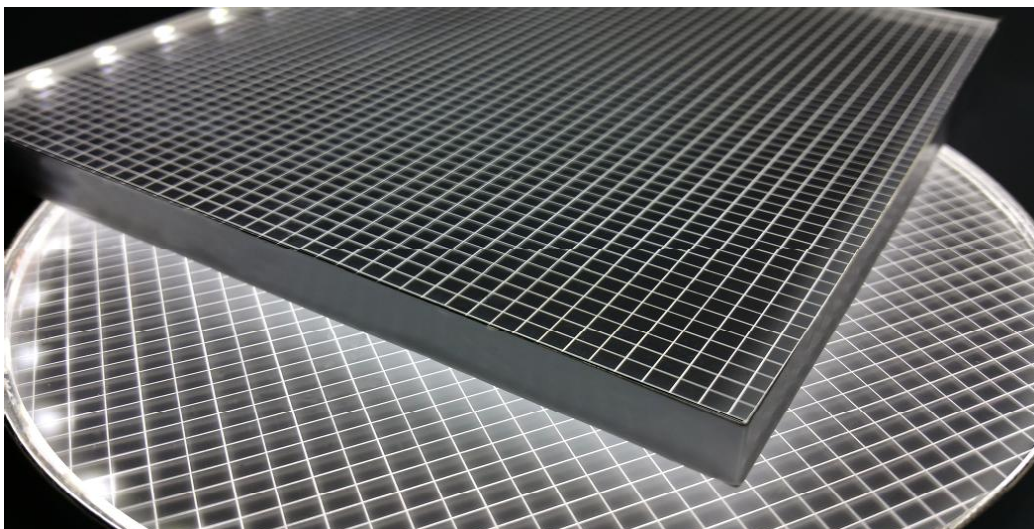

Description:	
Voltage	12-vdc / 24-vdc
Power	4.5-watts per linear foot of LED strip used to illuminate the panel
Weight	2-pounds per square foot
Size	4 x 4-inches to 48 x 96-inches
Color Temperature (K) ± 200	3,700, 5,300
Dimming	Yes, with pulse width dimmer
UL	Signs UL48
Operating Temperature	-4 ~ + 95°F
Life	70,000-hours, 3 year guarantee
Brightness	2,000-31,700 lux (dependent on size and quantity of LEDs used)
Application	Indoor
Construction	Acrylic

Illumice

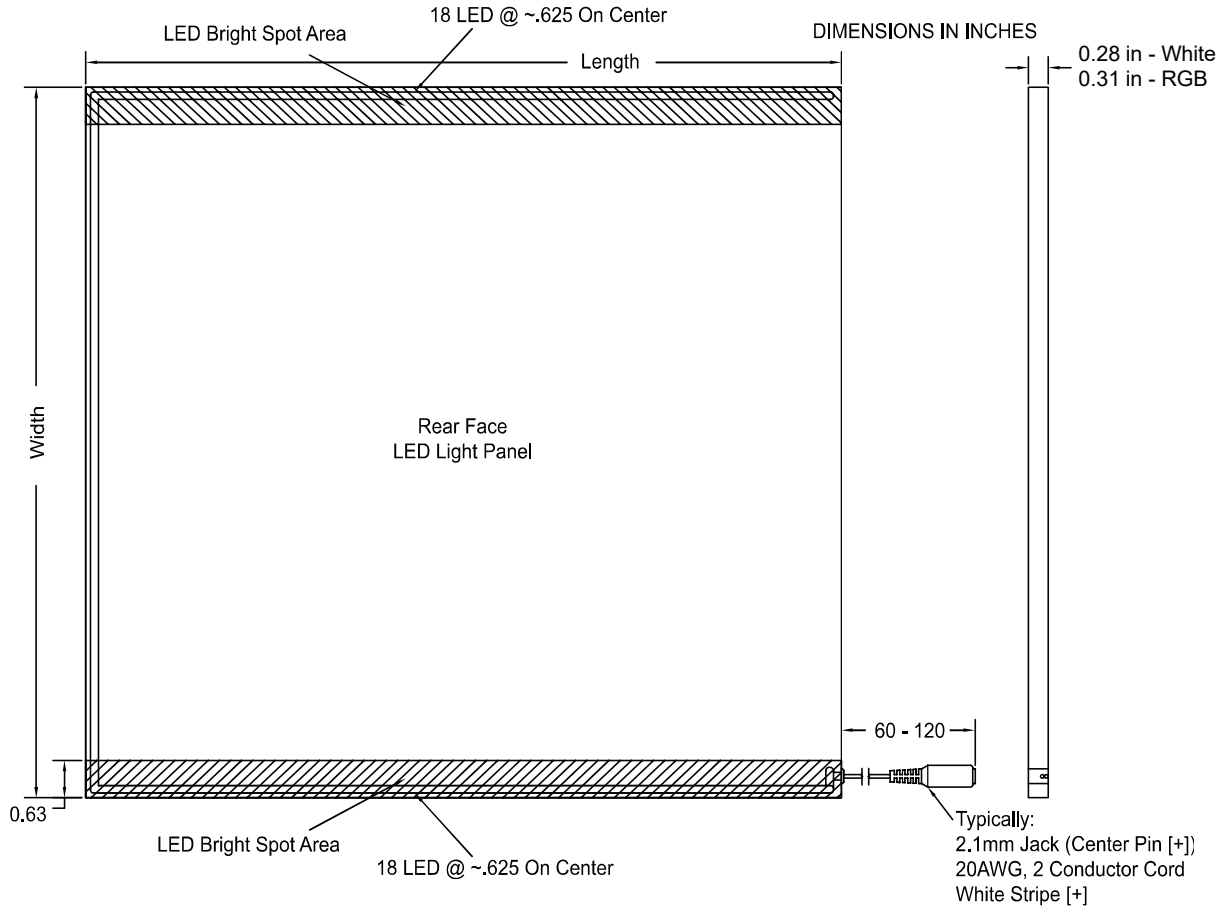

Examples of Panel Brightness

Size (inches)	Brightness (Lx)	Power	Lighted Edges
3.75 x 3.75	5,200	2.25	2
3.75 x 3.75	31,700	4.5	4
6 x 6	6,043	2	1
6 x 6	6,817	4	2
6 x 6	23,701	8	4
12 x 12	5,048	9	2
12 x 12	11,310	18	4
24 x 24	2,724	18	2
24 x 24	5,883	32	4

Instructions for Handling & Installation

Please read all directions before carrying and installing LED edge-lit panels with or without flip-open frame (using mounting clips).

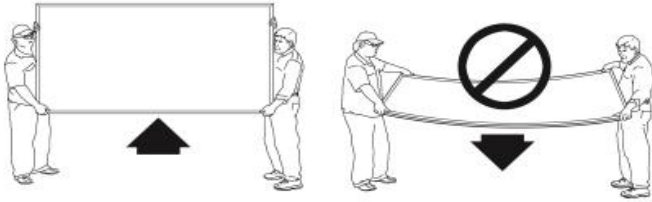

Step 1. Proper Handling of LED Edge-lit Panels & Light Boxes- Care should be taken to prevent breaking the acrylic light guide plate (LGP). While resting on a flat surface, raise one edge of the panel to a vertical position, lift and carry the panel in this position. Be careful to not pull on the power lead extending from the panel. Do not rest the panel on the power lead, damage to the wire's insulation may result.

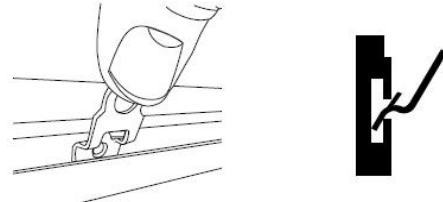

Step 2. Wall Mounting a Light Box- Insert the hanging clip into the channel on the top rear of the frame at approximately 45 degree angle.

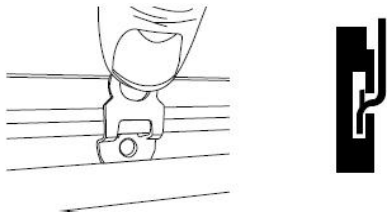

Step 3. Wall Mounting a Light Box Cont.- Using your thumb apply pressure to the upper portion of the clip, snapping it into the channel.

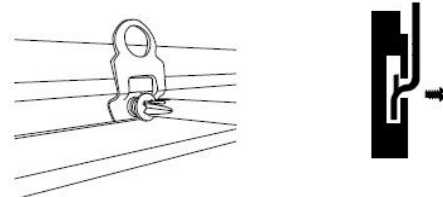

Step 4. Positioning Hanging Clip- Slide hanging clip to the desired location then insert and tighten locking screw using phillips screw driver. Repeat step 2 through 4 for second clip.